

SUBMITTAL DATA SHEET

CURB INLET HOOD

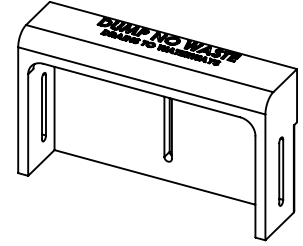

CURB INLET HOOD - NF R3222 REPLACEMENT

PART NUMBER	LABEL
MP-CH-NFR3222-B93	NONE
MP-CH-NFR3222-01-B93	"DUMP NO WASTE DRAINS TO WATERWAYS"
MP-CH-NFR3222-02-B93	"DUMP NO WASTE DRAINS TO LAKE SUPERIOR"

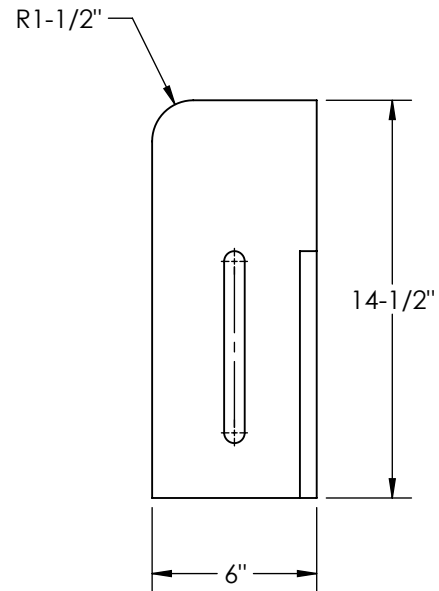
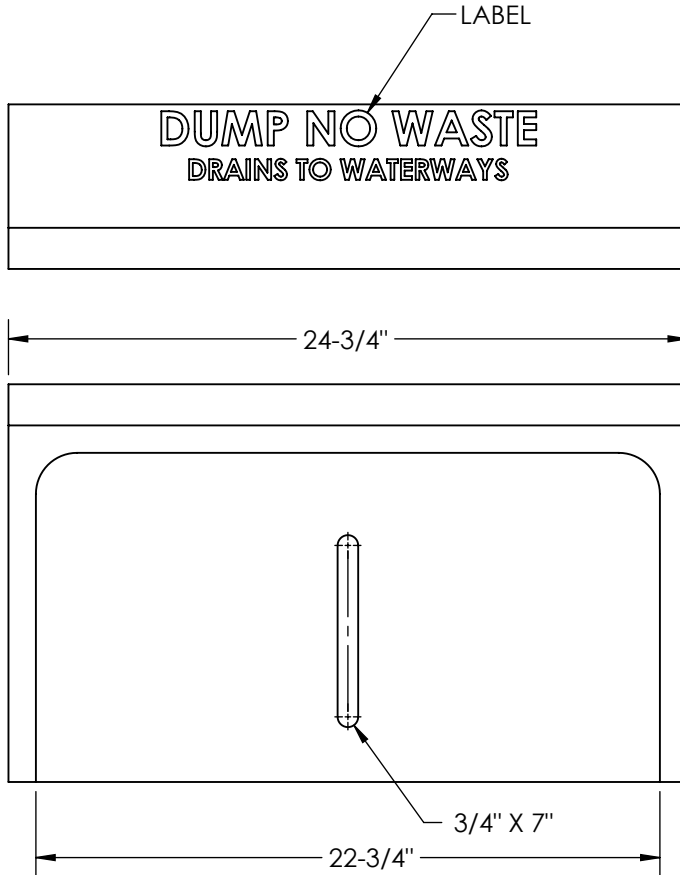

INFORMATION

- CURB INLET HOOD IS DESIGNED TO BE A REPLACEMENT FOR NF R3222
- CURB INLET HOOD MATERIAL IS POLYURETHANE
- THE COLOR IS BLACK
- WEIGHT IS 29.0 LBS

Argonics Inc. considers the information on this submittal sheet to be correct when published. Item and option availability, including specifications, are subject to change without notice.



ARGONICS INC.
 520 9th St. Gwinn, MI 49841
 906.226.9747 • 800.991.2746
 Fax: 906.226.9779
 www.argonics.com

Submitted By: